

Fiber Distribution Box Datasheet

» Description

Fiber Distribution Box (FDB) widely used as the distribution and terminal connection for various optical fiber systems. It provides fiber splicing, protection, splitting, distribution, fiber storage, fiber management integrates functions for the FTTX network. It is a perfect cost-effective solution-provider in the FTTx networks.

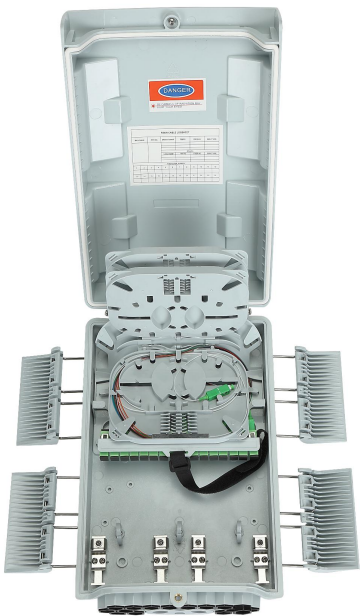

Plastic Fiber Distribution Box Datasheet

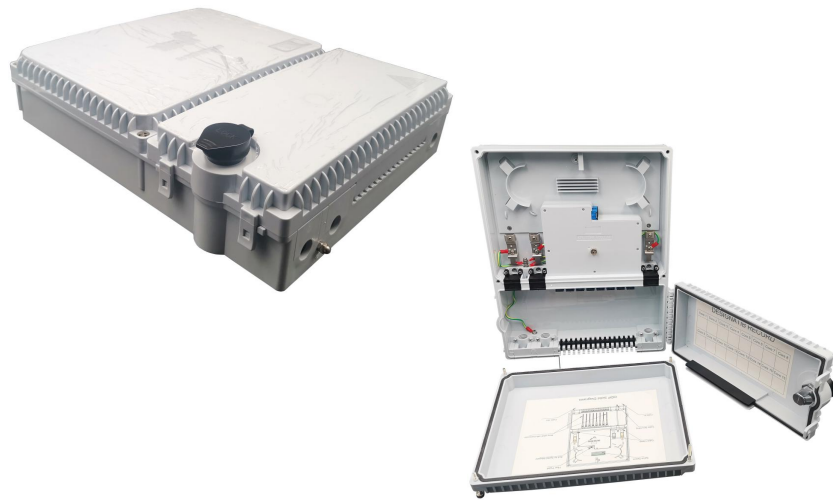

Model	SJ-OTB-SY-08
Capacity	8-16 Cores 1pc/2pcs 1x8 PLC Splitter
Dimension	345x275x85mm



Model	SJ-OTB-SY-05
Capacity	32 Cores SC Adapter 3pcs 1x8 PLC Splitter
Dimension	323x150x72mm



Model	SJ-OTB-SY-06
Capacity	96 Cores (6X16 F), 48 SC Adapter 3pcs 1x16 PLC Splitter
Dimension	450x180x150mm



Model	SJ-OTB-SY-04-A
Capacity	8 Cores SC/LC Adapter 1x8 PLC Splitter
Dimension	235x126x52mm



Model	SJ-OTB-SY-04
Capacity	8 Cores SC/LC Adapter 1x8 PLC Splitter
Dimension	235x126x52mm



Model	SJ-OTB-SY-03
Capacity	8 Cores SC/LC Adapter 1X8 PLC Splitter
Dimension	235x126x52mm

Plastic Fiber Distribution Box Datasheet



Model	SJ-OTB-SY-11A
Capacity	24 Cores, 8 Ports SC/LC Adapter 1x8 PLC Splitter
Dimension	280x175x70mm



Model	SJ-OTB-SY-11B
Capacity	36 Cores, 16 Port SC/LC Adapter 1x16 PLC Splitter
Dimension	280x190x95mm



Model	SJ-OTB-SY-11C
Capacity	32 Cores, 16 PCS LC DX Adapter MPO-LC UPC Patch Cord
Dimension	280x190x95mm

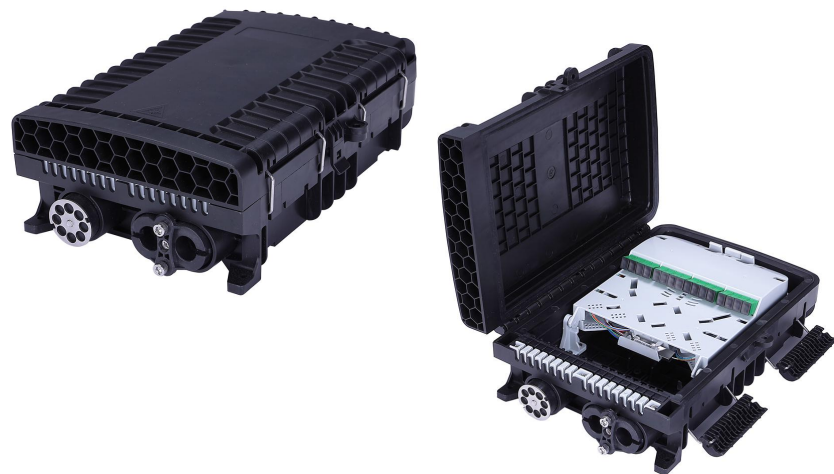

Model	SJ-OTB-SY-13A
Capacity	16 Cores, 16 Port SC/LC Adapter 1x16 PLC Splitter
Dimension	300x215x100mm



Model	SJ-OTB-SY-13B
Capacity	16 Cores 1x16 SC Mini Steel Tube Splitter
Dimension	300x215x100mm



Model	SJ-OTB-SY-13C
Capacity	16 Cores 1X16 Cassette LGX Optical Splitter
Dimension	300x215x100mm

Plastic Fiber Distribution Box Datasheet



Model	SJ-FTTH-SK-18
Capacity	Splice 96 Cores (4x24 F) 24 Adapters, 4pcs 1x8 PLC Splitter
Dimension	340X210X95mm



Model	SJ-FTTH-SK-18-B
Capacity	Splice 96 Cores, 24 Adapter 3pcs 1x8 PLC Splitter
Dimension	340X210X95mm



Model	SJ-FTTH-SK18-A
Capacity	Splice 16 Cores, 16 Adapter 1pc 1x16 PLC Splitter
Dimension	275x175x82mm



Model	SJ-FTTH-SK18-A1
Capacity	Splice 16 Cores, 16 Adapter 1x16 PLC Splitter
Dimension	290x210x90mm



Model	SJ-FTTH-SK18-B
Capacity	Splice 16 Cores, 16 Adapter 1x16 Cassette LGX PLC Splitter
Dimension	275x175x82mm



Model	SJ-FTTH-SK18-B1
Capacity	Splice 16 Cores, 16 Adapter 1x16 Cassette LGX PLC Splitter
Dimension	290x210x90mm

Plastic Fiber Distribution Box Datasheet



Model	SJ-FTTH-SK18-C
Capacity	Splice 16 Cores, 16 Adapter 1pc 1x16 PLC Splitter
Dimension	330x210x90mm



Model	SJ-FTTH-SK18-D
Capacity	Splice 16 Cores, 8 Adapter 1pc 1x8 PLC Splitter
Dimension	330x210x90mm



Model	SJ-FTTH-SK18-D2
Capacity	8 Pcs Pre-Terminated Mini SC adapter 1 Pcs of 1x8 PLC Splitter
Dimension	330x210x87mm



Model	SJ-FTTH-SK18-E
Capacity	Splice 16 Cores, 8 Adapter 1pc 1x8 PLC Splitter
Dimension	275x175x80mm



Model	SJ-FTTH-SK18-F
Capacity	48 Splice, 16 Ports SC/APC Adapter 1x16 SC Mini Steel Tube Splitter
Dimension	330x210x120mm



Model	SJ-FTTH-SK18-G
Capacity	8 Cores 1x8 SC Mini Steel Tube Splitter
Dimension	280x182x82mm

Plastic Fiber Distribution Box Datasheet

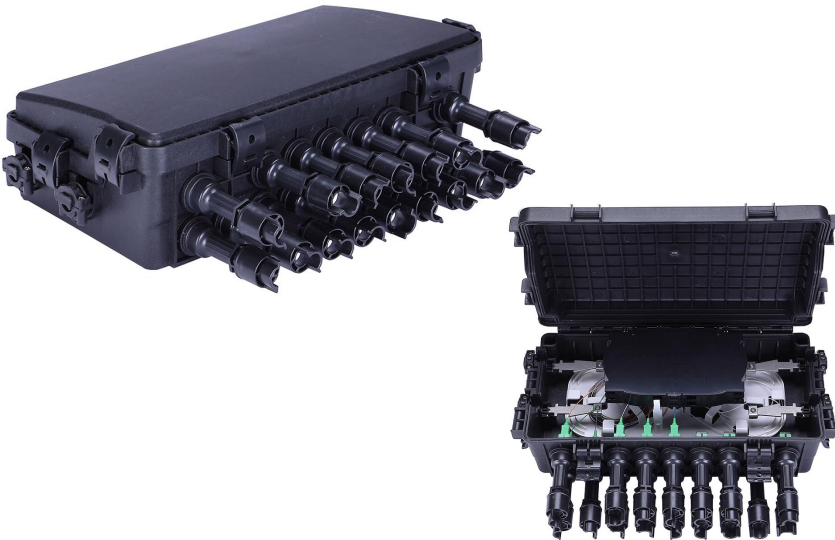

Model	SJ-FTTH-SK18-H
Capacity	48 Splices, 16 ports of Waterproof SC/APC adapter
Dimension	340x280x100mm



Model	SJ-OTB-SY-10
Capacity	16 Core, Huawei Mini SC IP Rated Waterproof Connectors 1x16 SC Mini Steel Tube Splitter
Dimension	210x240x120mm



Model	SJ-OTB-SY-10A
Capacity	8 Core, Huawei Mini SC IP Rated Waterproof Connectors 1x8 SC Mini Steel Tube Splitter
Dimension	320x200x100mm

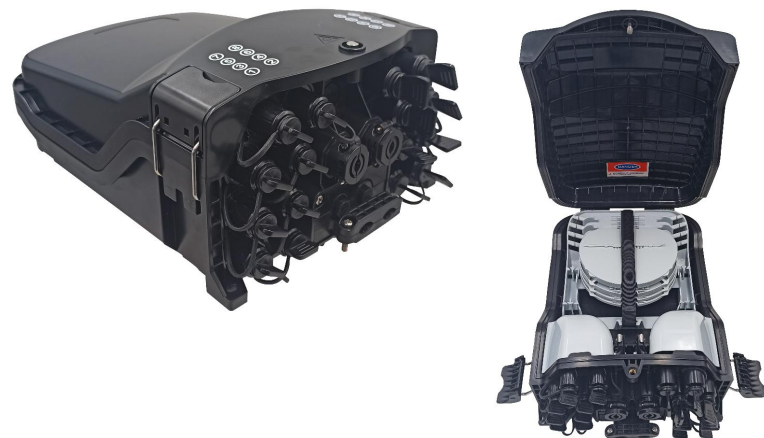

Model	SJ-OTB-SY-10B
Capacity	16 Core, Huawei Mini SC IP Rated Waterproof Connectors 1x16 SC Mini Steel Tube Splitter
Dimension	320x215x133mm

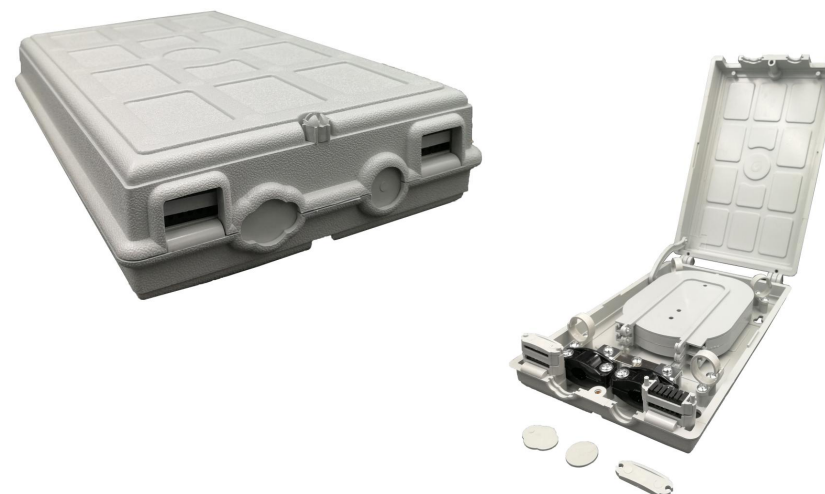

Model	SJ-OTB-SY-02
Capacity	24 Cores
Dimension	265x155x55mm



Model	SJ-OTB-SY-01
Capacity	12 Cores
Dimension	198x112x45mm

Plastic Fiber Distribution Box Datasheet

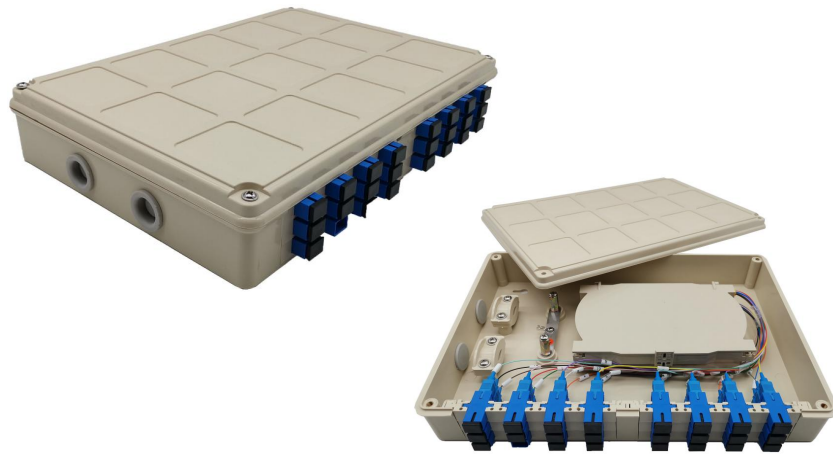

Model SJ-OTB-ST-07-A

Capacity 24 Cores, 24pcs SC Adapter

Dimension 300x210x55mm



Model SJ-OTB-ST-07

Capacity 24 Cores, FC Adapter

Dimension 300x210x55mm



Model SJ-OTB-ST-06-A

Capacity 12 Cores, 12pcs SC Adapter

Dimension 300x150x55mm



Model SJ-FTTH-SK19-1

Capacity 1x16 Cassette LGX PLC Splitter

Dimension 390x270x115mm



Model SJ-FTTH-SK-19

Capacity Splice 24 Cores (2x24 F)
24 Adapters

Dimension 390x270x115mm



Model SJ-ODB-SQ13-A

Capacity 24 Cores
1x16 Cassette LGX PLC Splitter

Dimension 330x240x95mm

Plastic Fiber Distribution Box Datasheet



Model	SJ-ODB-SK10
Capacity	24 Cores 1x16 PLC Splitter
Dimension	340x260x110mm

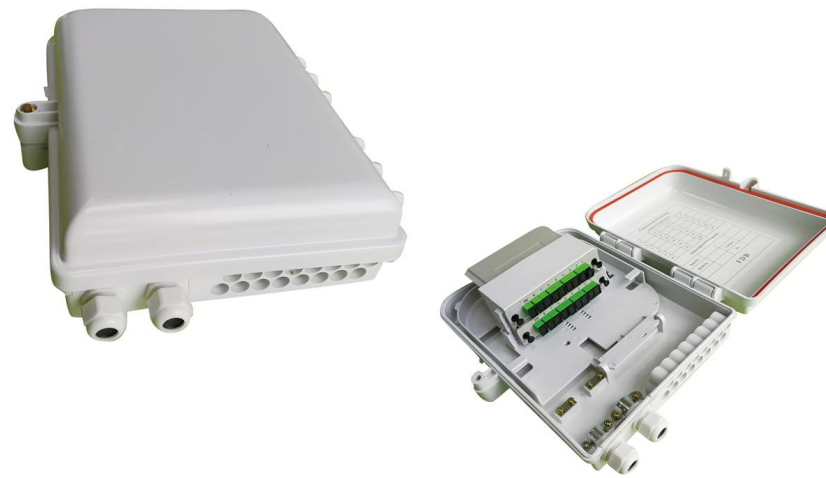

Model	SJ-ODB-SK09-A
Capacity	16 Cores 1x16 Cassette LGX PLC Splitter
Dimension	325x275x95mm



Model	SJ-ODB-SK09
Capacity	16 Cores 1x16 PLC Splitter
Dimension	325x275x95mm



Model	SJ-ODB-SK07-B
Capacity	16 Cores 1x16 Cassette LGX PLC Splitter
Dimension	310x235x100mm



Model	SJ-ODB-SK07-A
Capacity	16 Cores 1x16 PLC Splitter
Dimension	310x235x100mm



Model	SJ-ODB-SK07-A
Capacity	16 Cores 1x16 PLC Splitter
Dimension	310x235x100mm

Plastic Fiber Distribution Box Datasheet



Model	SJ-ODB-SK06-C24
Capacity	24 Cores 1x8 PLC Splitter
Dimension	320x280x105mm



Model	SJ-ODB-SK06-C12
Capacity	12 Cores 1x8 PLC Splitter
Dimension	240x220x70mm



Model	SJ-ODB-SK06-B
Capacity	24 Cores 1x16 Cassette LGX PLC Splitter
Dimension	330x240x95mm

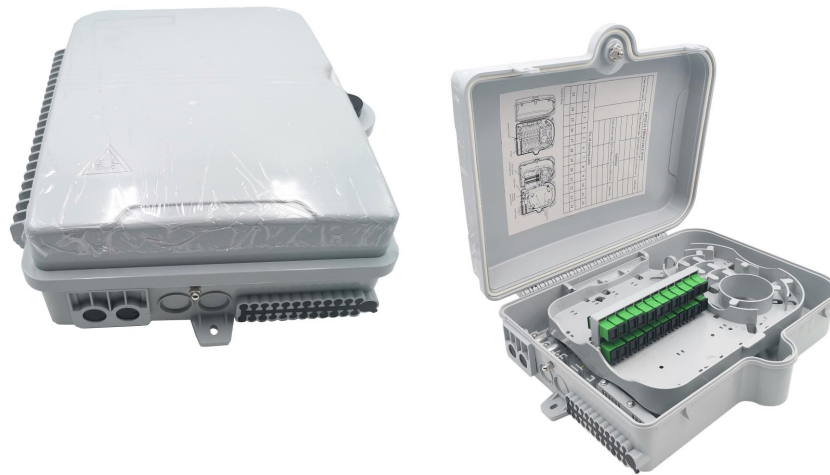

Model	SJ-ODB-SK06-A-1
Capacity	24 Cores, 1x16 PLC Splitter
Dimension	320x240x100mm



Model	SJ-ODB-SK06-A
Capacity	24 Cores, 1x16 PLC Splitter
Dimension	320x240x100mm

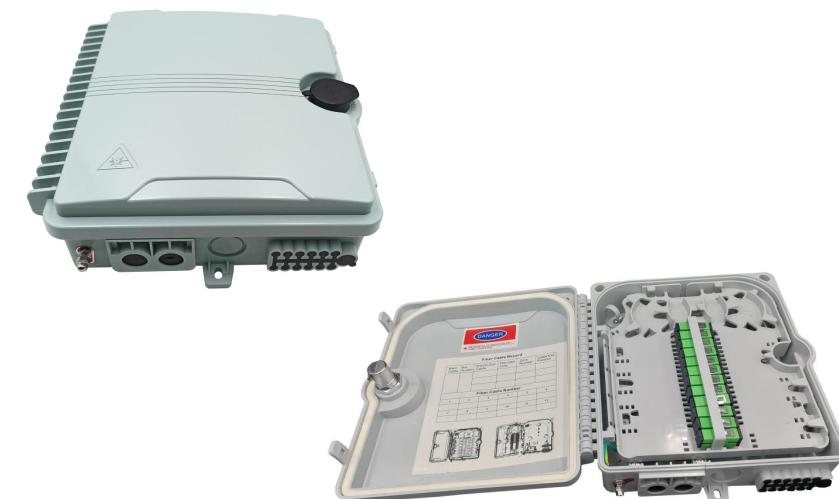

Model	SJ-ODB-SK05
Capacity	12 Cores, 1x8 PLC Splitter
Dimension	225x215x65mm

Plastic Fiber Distribution Box Datasheet



Model	SJ-ODB-SK04-B
Capacity	8 Cores, 1x8 PLC Splitter
Dimension	225x215x55mm



Model	SJ-ODB-SK04-A
Capacity	8 Cores, 1x8 PLC Splitter
Dimension	225x215x55mm



Model	SJ-ODB-04A-1
Capacity	8 Cores, 1x8 PLC Splitter
Dimension	215x180x50mm



Model	SJ-ODB-SK03
Capacity	8 Cores, 1x8 SC PLC Splitter
Dimension	210x215x50mm



Model	SJ-ODB-SK03-B
Capacity	8 Cores, 1x8 SC PLC Splitter
Dimension	240x190x50mm



Model	SJ-ODB-SK03-A
Capacity	8 Cores, 1x8 SC PLC Splitter
Dimension	230x190x50mm

Plastic Fiber Distribution Box Datasheet



Model	SJ-ODB-SK02
Capacity	2 Cores, 1x2 PLC Splitter
Dimension	185x135x41mm



Model	SJ-ODB-SK01-6
Capacity	6 Cores, 1x4 PLC Splitter
Dimension	185x135x41mm



Model	SJ-ODB-SK01-4
Capacity	4 Cores, 1x4 PLC Splitter
Dimension	185x135x41mm



Model	SJ-ODB-SK01-4A
Capacity	4 Cores, 1x4 PLC Splitter
Dimension	210x140x45mm



Model	SJ-ODB-SK01-2
Capacity	2 Cores, 1x2 PLC Splitter
Dimension	185x135x41mm

SMC Fiber Distribution Box Datasheet



Model	SJ-ODB-8-SMC
Capacity	1x8 Cassette LGX PLC Splitter
Dimension	310x245x90mm



Model	SJ-ODB-16 PLC-SMC
Capacity	1x16 Cassette LGX PLC Splitter
Dimension	380x290x110mm



Model	SJ-ODB-16PLC-SMC-2
Capacity	2pcs of 1x16 Cassette LGX PLC Splitter
Dimension	490X370X140mm



Model	SJ-ODB-24-SMC
Capacity	24 Cores
Dimension	380x290x110mm



Model	SJ-ODB-48-SMC
Capacity	48 Cores
Dimension	475x365x135mm



Model	SJ-ODB-72-SMC
Capacity	72 Cores
Dimension	490x405x160mm

Metal Fiber Optic Distribution Box Datasheet



Model	SJ-ODB-M18-B
Capacity	144 Cores
Dimension	650x500x160mm



Model	SJ-ODB-M18-A
Capacity	96 Cores
Dimension	455x405x160mm



Model	SJ-ODB-M18
Capacity	72 Cores
Dimension	455x405x150mm



Model	SJ-ODB-M14
Capacity	48 Cores
Dimension	450x450x140mm



Model	SJ-ODB-M12
Capacity	48 Cores
Dimension	550x500x180mm



Model	SJ-ODB-M11
Capacity	32 Cores
Dimension	470x370x130mm

Metal Fiber Optic Distribution Box Datasheet



Model	SJ-ODB-M15
Capacity	48 Cores, 1x32 Cassette PLC Splitter
Dimension	650x450x200mm



Model	SJ-ODB-M16
Capacity	48 Cores, 1x32 Cassette PLC Splitter
Dimension	420x320x170mm

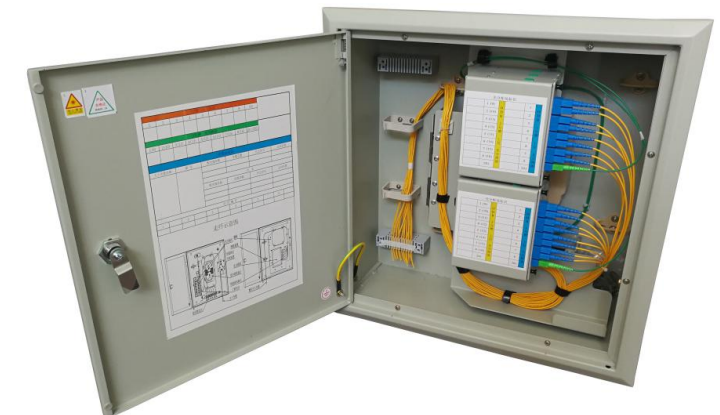

Model	SJ-ODB-M17
Capacity	48 Cores, 2 pcs 1x16 Cassette LGX PLC Splitter
Dimension	415x400x150mm



Model	SJ-ODB-M01
Capacity	24 Cores
Dimension	360x360x85mm

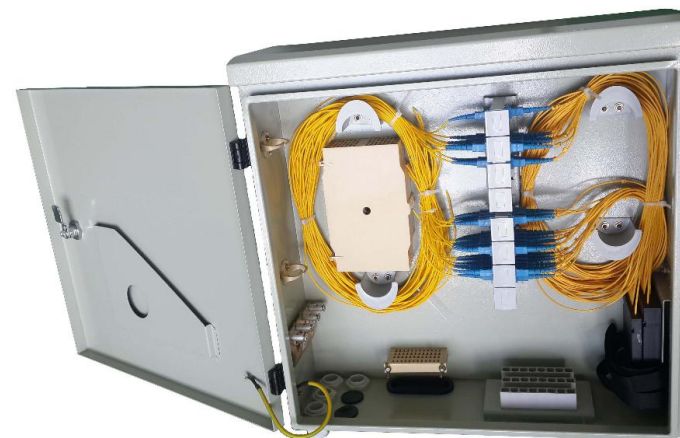

Model	SJ-ODB-M02
Capacity	24 Cores, 1x16 Cassette LGX PLC Splitter
Dimension	450x450x140mm

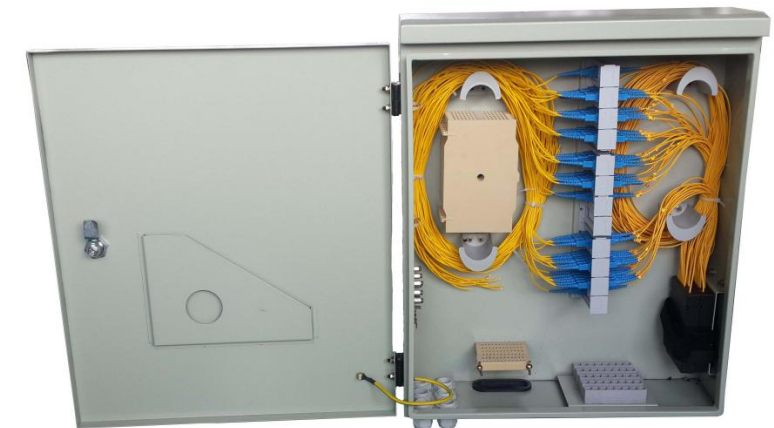

Model	SJ-ODB-M03
Capacity	72 Cores, 1x32 Cassette LGX PLC Splitter
Dimension	550x450x140mm

Metal Fiber Optic Distribution Box Datasheet

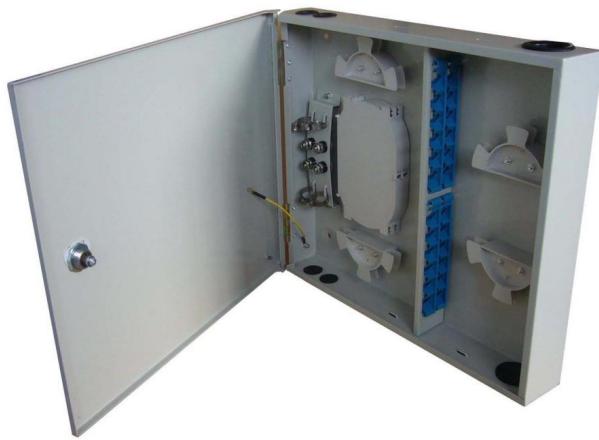

Model	SJ-ODB-M04
Capacity	24 Cores
Dimension	450x380x70mm



Model	SJ-ODB-M05
Capacity	48 Cores
Dimension	450x380x105mm

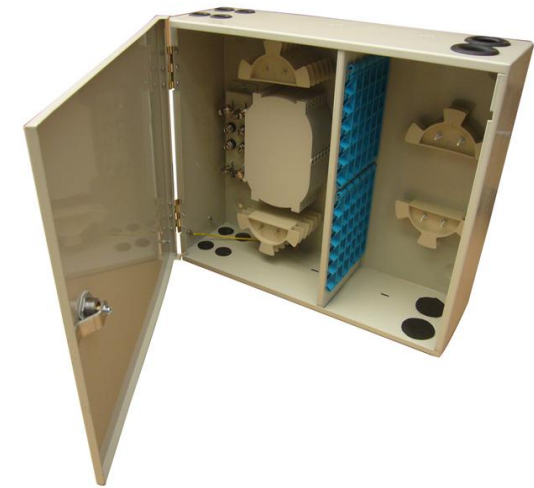

Model	SJ-ODB-M06
Capacity	72 Cores
Dimension	450x380x105mm



Model	SJ-ODB-M07
Capacity	12-24 Cores
Dimension	400x380x80mm



Model	SJ-ODB-M19-32
Capacity	2PCS 1X16 Splitter
Dimension	450X350X120mm



Model	SJ-ODB-M19-16
Capacity	1X16 Splitter
Dimension	370X330X110mm